

The Confetti Family

Just like little pieces of paper floating from the sky can create an amazing image in a parade, Confetti™ offers a fun way to deliver light in small packages. The Confetti™ family's array of options include recessed downlights, wallwashers, eyeball adjustables and surface offerings in the form of tiny monopoints and pendants. Have some fun and throw some Confetti™ to light your space.

PROJECT:

TYPE:

SPECIFIER:

DATE:

Key Points (CF1D-RP)

Housing

- Distinctive, 12" long, 1" diameter fully accent pendant with field cuttable suspension/power cord up to 56" long.
- Flangeless and Flanged trims available for retrofit type installation, no housing required.
- Unique design of Flangeless Trim allows for truly flat, smooth ceilings when using the Confetti™ Counter Bore Hole Saw. For optimal installation we recommend this tool. Order under accessories.
- Flanged trim features micro-bite wing springs.
- White or Black standard finish for housing and flanged trims.
- Trim bezels are black for low brightness and glare control.
- Us Listed – Damp
- Wire pigtails are CMP rated for plenum use

Source / Optics

- 2700K, 3000K and 3500K available.
- 3 beamspreads available - 30°, 35° and 45°
- Up to 1598 Peak CD
- Up to 456 delivered lumens delivered from a distinctive slender form
- <3 MacAdam Steps (<3SDCM) for fixed white
- 90 CRI, 60+ R9 Standard
- [View Photometry](#)

Drivers

- Configurable driver box for up to 4 Confetti fixtures on a single remote driver. Can be mixed with other fixtures within the Confetti™ family. Quantity of driver boxes needs to be specified based upon number of fixtures and control zone requirements.
- Remote Universal EldoLED driver, 120-277V
- Flicker free to IEEE 1789-2015 available with EldoLED and TruPhase™ selections
- 0-10, DALI-2, TruPhase™

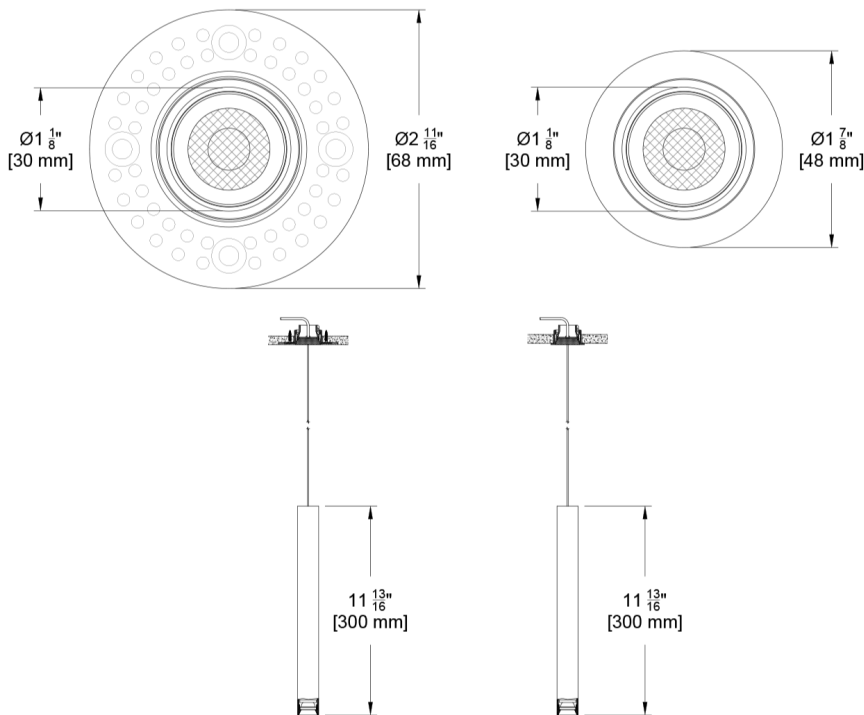

Ordering Codes

PROJECT:

SPECIFIER:

DATE:

TYPE:

QUANTITY:

Ordering Code Example: CF1D-RP-Z-C6-30-36-CFD/E1-3-B-WHT-K-CFCBHS

FIXTURE	TRIM	SOURCE / WATTS	CCT	BEAM	DRIVER / CONTROL	DRIVER QUANTITY	TRIM FINISH	HEAD FINISH	ACCESSORIES
CF1D-RP									
Confetti™ 1" Round Pendant	<p>Z Flangeless Trim*</p> <p>F Flanged Trim^</p> <p>* Recommend that CFCBHS tool listed under Accessories be purchased for easy installation. Refer to Ceiling Cutouts and Dimensions for details. Trim finish does not apply to flangeless trims.</p> <p>^ Must specify trim finish for flanged trim</p>	<p>Citizen</p> <p>C6 ●● 6W 456Lm* 90+CRI, 60+R9</p> <p>● Supports CA Title 24 & JA8 Compliance</p> <p>* Based on Deep Regress with 45° beamsread</p> <p>View Photometry</p>	<p>27 2700K</p> <p>30 3000K</p> <p>35 3500K</p>	<p>30 Medium</p> <p>35 Flood</p> <p>45 Flood</p>	<p>CFD/E1 0-10° 0.1%, UNV (120-277V) log</p> <p>CFD/E2 DALI-2* 0.1%, UNV (120-277V) log</p> <p>CFD/E3 0-10° 0.1%, UNV (120-277V) linear</p> <p>K No driver required. (CFD box has been specified with another Confetti product)</p> <p>TR2 TruPhase™ 0.1%, (120-120V) log Up to 20W Forward and Reverse compatible Phase Dimming Static White & Ambient Dim only</p> <p>* Remote driver only.</p>	<p># Specify number of drivers</p> <p>Must specify # of driver boxes based upon control requirements and 1-4 fixtures per driver.</p> <p>See Electrical Configuration and Control section of cut sheets for details.</p>	<p>B Black Paint</p> <p>W White Paint</p> <p>K Blank for use with Flangeless</p>	<p>B Black Paint</p> <p>W White Paint</p>	<p>CFCBHS Confetti Counter Bore Hole Saw for Flangeless Trims</p> <p>Controls</p> <p>ATH Lutron Athena Wireless Node <i>Must be used with E2 driver</i></p> <p>Recommended for proper installation of Flangeless Trims. Only one required per project.</p>

Ceiling Cutouts and Dimensions

Round Flangeless

Deep Regress (DR)

(CF1D-RP-DR-Z-C6)

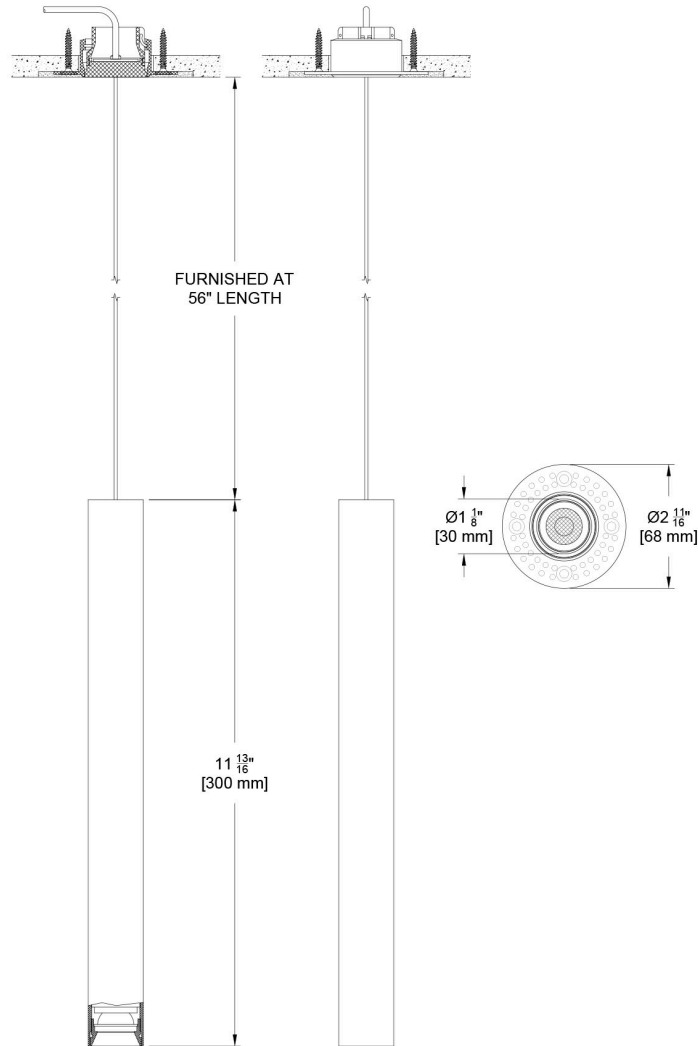

Round Flanged

Deep Regress (DR)

(CF1D-RP-DR-F-C6)

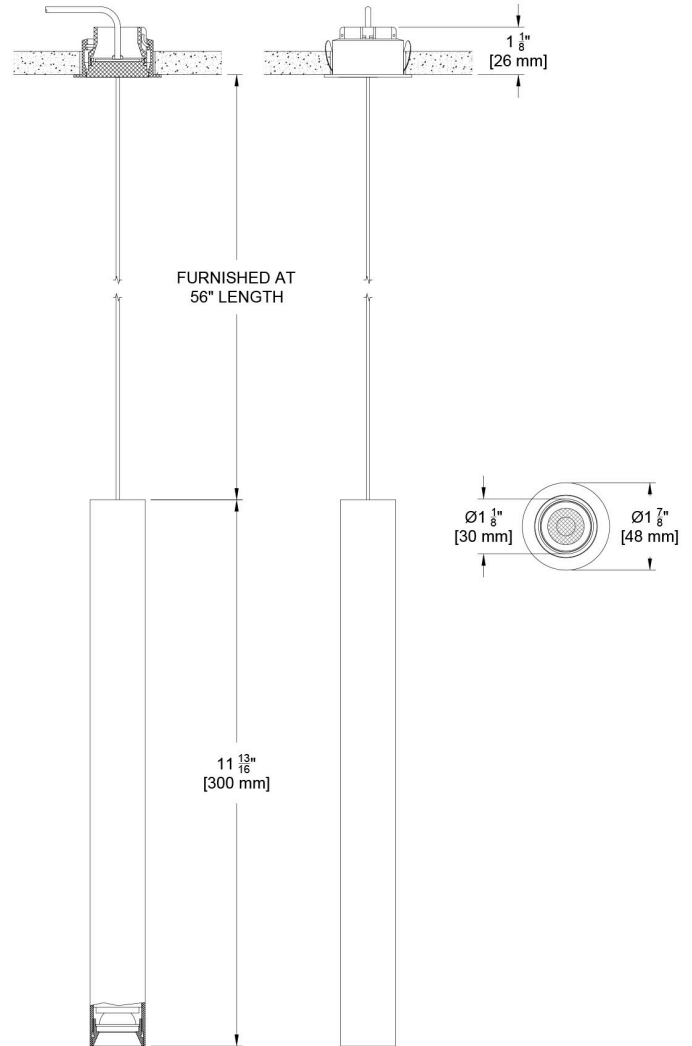

Flangeless Mount Detail

CFCBHS REQUIRED ALONG WITH POWER DRILL FOR THIS CUTOUT. SEE ACCESSORIES

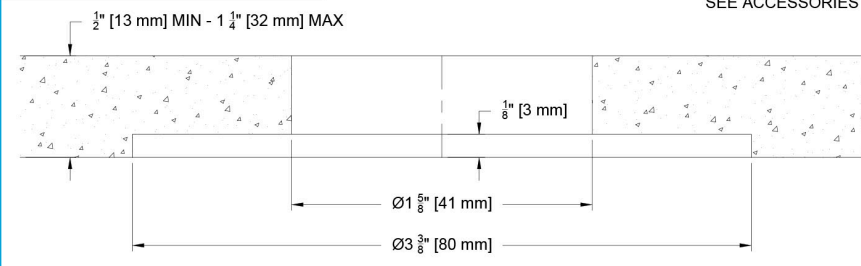

*Confetti Counter Bore Hole Saw (CFCBHS)

Photometric Table

All data below are delivered lumens based on goniometer measurements of production representative product. All lumen values can vary +/- 10% from LED manufacturer rated nominal flux.

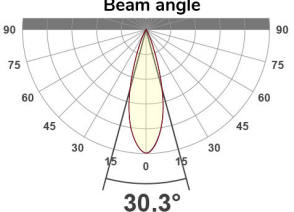
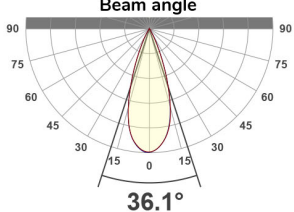
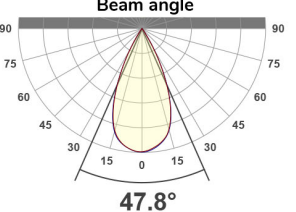
ROUND Beamspreads		30°					36°				45°			
Source	System watts (W)	Delivered Lumens (lm)	Lumens/Watt	Peak CD	10% Field	Delivered Lumens (lm)	Lms/Watt	Peak CD	10% Field	Delivered Lumens (lm)	Lms/Watt	Peak CD	10% Field	
Pendant	C6	6	451	72	1598	50°	448	71	1195	56°	456	72	780	66°
CCT Multiplier		 <p style="text-align: center;">Beam angle 30.3°</p>					 <p style="text-align: center;">Beam angle 36.1°</p>				 <p style="text-align: center;">Beam angle 47.8°</p>			
CCT	Citizen													
2700	0.95													
3000	1.00													
3500	1.02													
4000	1.03													

All measurements are delivered lumens based on 3000K unless otherwise noted below.
 ISO cd Plots based on Pendant with C6 Source.
 Refer to photometry tab on product page for exact ISO cd plot and IES files.

Color Data

All Color information is based on goniometer measurements of production representative product. All values can vary +/- 10% from LED manufacturer data range as listed on their datasheet.

Citizen Source - C6

- <2 MacAdam Ellipse (<2 SDCM)
- 90+ CRI and RF
- 60+R9, Hue Bin 1 and 16

94 CRI	74 R9
91 RF	100 RG

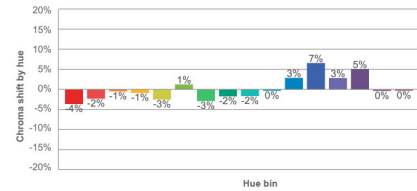
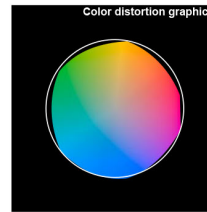
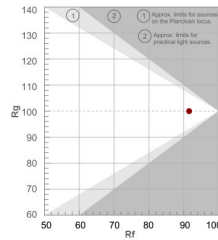
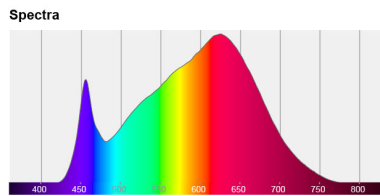
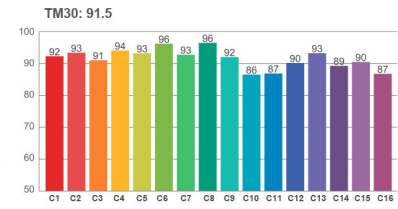
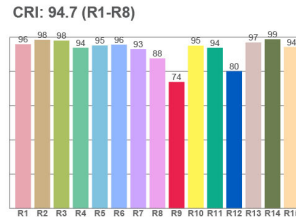

Electrical Configuration and Control

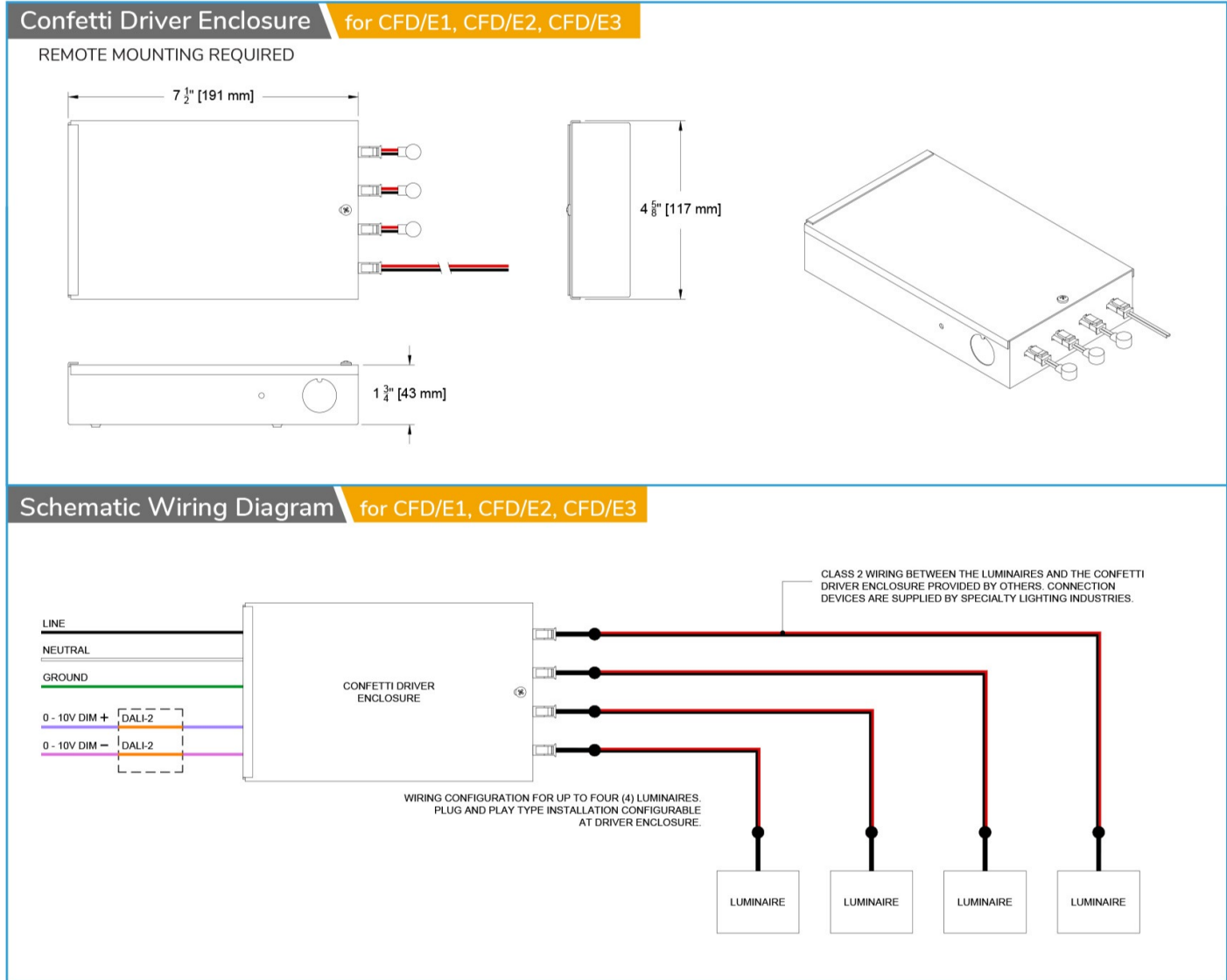

Electrical Configuration and Control

System Wiring Diagram for Confetti Driver Enclosure

for CFD/E1, CDF/E2, CFD/E3

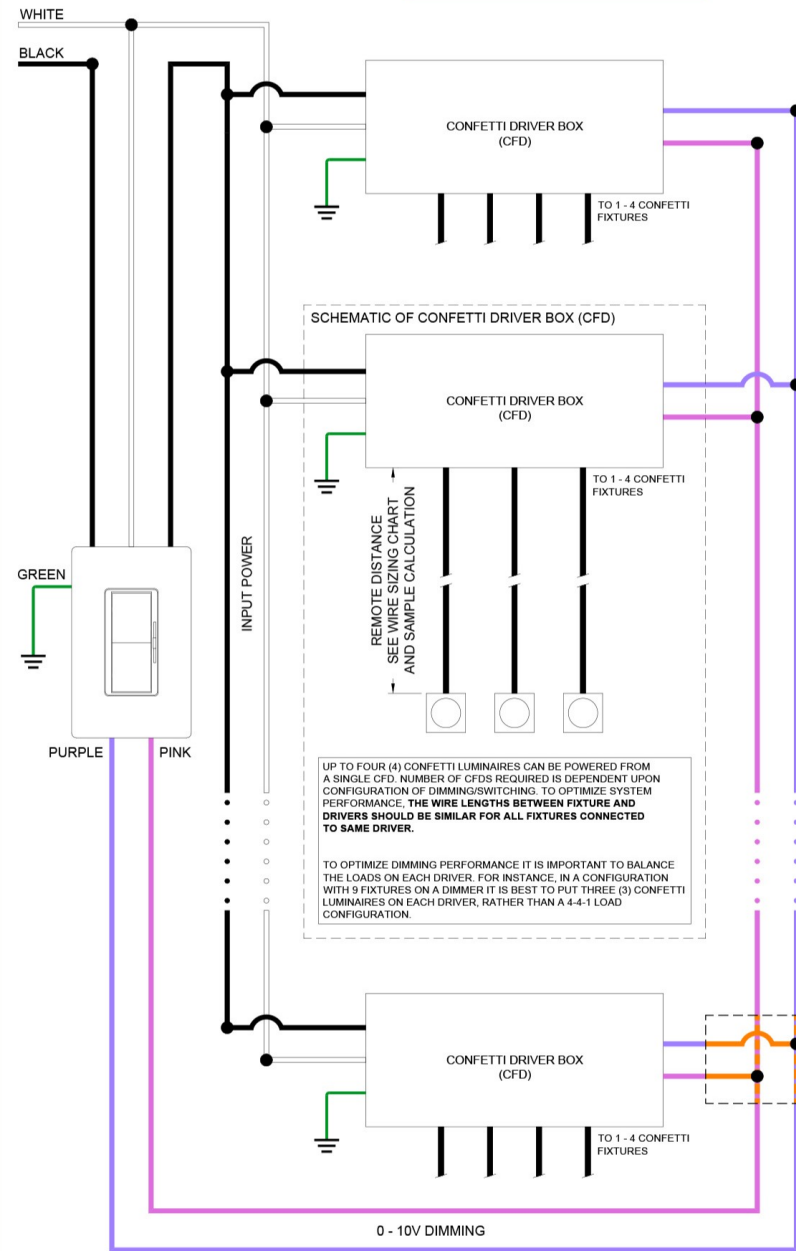

Remote Wire Sizing Chart CFD/E1, CFD/E2, CFD/E3 Drivers

for All Point Sources

Max Remote Distance*	Wire Size
46 ft (14 m)	AWG 20 (0.52 mm ²)
72 ft (22 m)	AWG 18 (0.82 mm ²)
118 ft (36 m)	AWG 16 (1.31 mm ²)

* Max Remote Distance calculated by adding the sum of remote distances for all fixtures connected to driver, i.e. four (4) fixtures connected to a single driver, each 20 feet from driver, the remote distance is 80 feet.

For more information and dimmer compatibility refer to driver manufacturer's website:
EldoLED (E2) Drivers - <https://eldoled.com/product/dualdrive>

EXAMPLE 3 Fixtures @ Various Length each Calculate Max Remote Distance= Add the sum of all fixture lengths

1-4 Confetti Fixtures Max

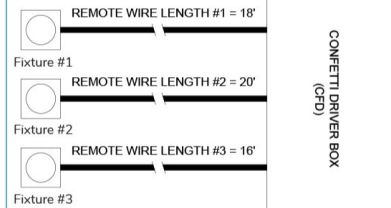

Fixture #1 Remote Wire length= 18'
Fixture #2 Remote Wire Length=20'
Fixture #3 Remote Wire Length=16'
Total Remote Distance = 54'

54' Requires AWG 18 wire because it is less than 72ft maximum distance listed for AWG18.

Note: For the CF1D-RP fixture add 5 feet to remote distance lengths to include the suspension length of the pendant wiring in voltage drop calculations.

FOR DALI-2 CONTROL WIRE FROM DRIVER ARE ORANGE

Electrical Configuration and Control

System Wiring Diagram for Confetti - TruPhase™ Driver

for TR2

